

Signalisation System

ALSI EX

Instruction manual

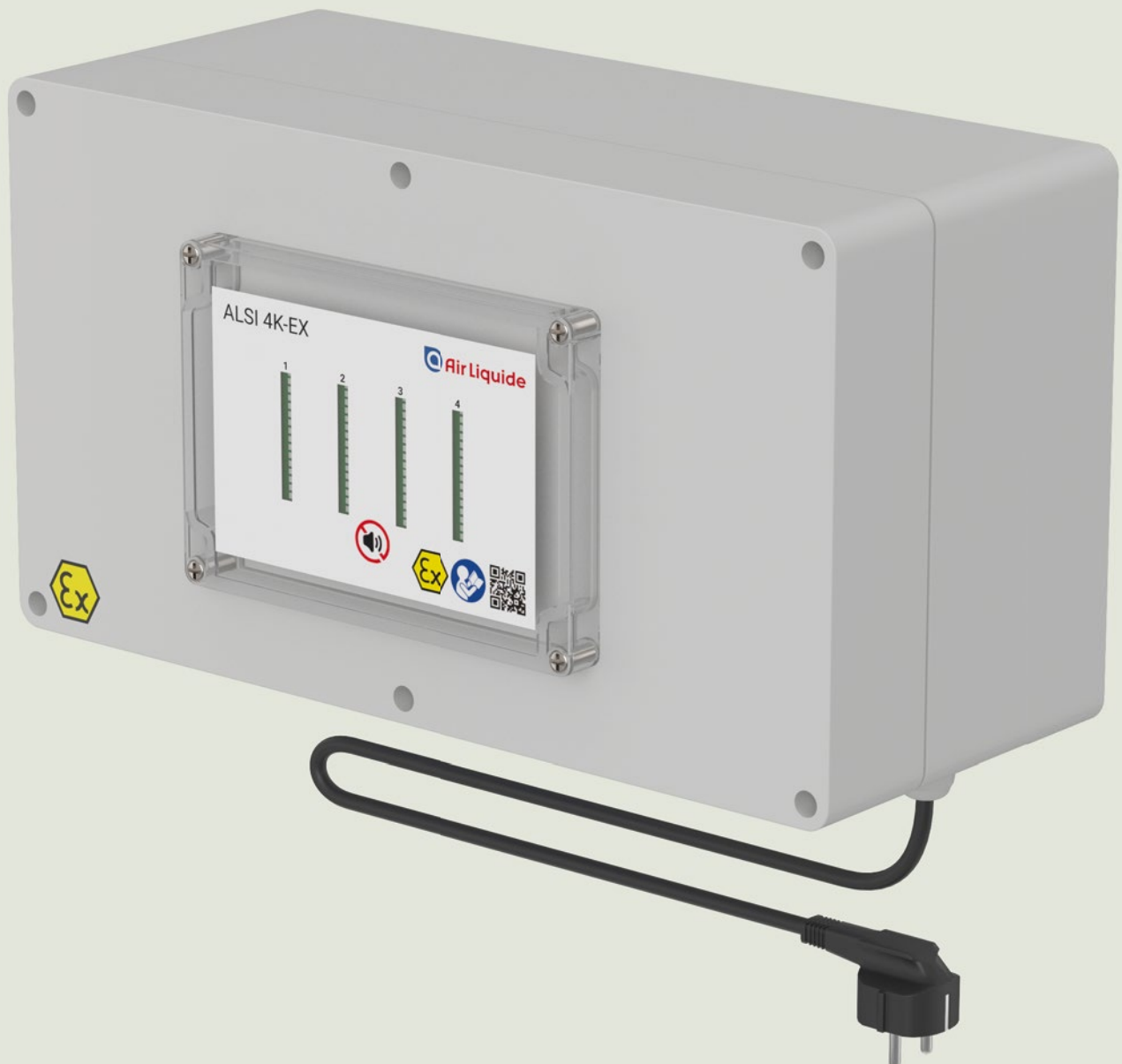

Signalisation System ALSI EX

Table of contents

Page

2	User notifications	3
2.1	Warning / Danger symbols	3
2.2	Symbol explanations	3
3	General information	3
3.1	Guidelines and general information	3
3.2	Warranty and liability	3
4	Safety instructions	4
4.1	User responsibilities	4
4.2	Personnel duties	4
5	Identification	4
5.1	Name plate	4
6	Use	5
6.1	Function	5
6.2	Use in hazardous areas	5
7	Installation	6
7.1	General	6
7.2	Wall mounting	6
7.3	Create mains connection	6
7.4	Sensor connections for Ex models	7
8	Starting Operation	8
8.1	Overview	8
	Explanation	8
8.2	Configuring the channel	8
8.2.1	Lid is unscrewed from the box	8
8.2.2	Select whether the channel should be enabled on "Enable channels"	8
8.2.3	Select whether the channel is inverted or not (5)	8
8.2.4	Select if the chosen channel should be...	8
8.2.5	On the input selector (3), select 0-10V / 4-20mA	9
8.2.6	Top, bottom and alarm levels are set as follows	9
8.3	Alarm 2 – Deactivation	10
9	Documents	11
10	Wiring diagram	12

2 User notifications

2.1 Warning / Danger symbols



These notes identify hazards that could result in moderate or minor injury if not avoided.



These notes identify hazards that could likely result in serious injury or death if not avoided.



These notes identify hazards with the potential for property damage.



Notes concerning use specifically in hazardous areas.

2.2 Symbol explanations

The following symbols are used in these instructions: Perform actions in a specific order:

1. First action
2. Second action
3. ...
4. • written following a bullet

3 General information

This guide will give you all the necessary information for operating and installing an Air Liquide Signalisation System ALSI EX. In this notice, the monitoring system is called the ALSI EX.

3.1 Guidelines and general information

- ALSI EX complies to EU directives and standards for electrical safety and electromagnetic compatibility. Improper use can result in damage to persons and objects. Improper use, installation, or operation nullifies any guarantee.
- When used in installations and under environmental conditions requiring higher safety standards, the requirements and regulations of your country must be observed.
- Always keep the equipment and the ALSI EX freely accessible.
- Modifications of the equipment and the connection of additional devices are in the responsibility of the operator. These steps must be checked and, if necessary, corrected by the operator.
- Accessories and options are optimally adapted to the device. Therefore, do not use custom solutions. Any modifications to the device and connection of auxiliary devices is the responsibility of the operator and must be checked by the user.
- For storage and transport, the unit should not be exposed to extreme temperatures, shock, or vibration.
- Notes and information on operating specifications can be provided on request.

3.2 Warranty and liability

Our „General Sales and Delivery Conditions“ apply as a rule. This is made available to the user at the latest at the time of contract signing. Warranty and liability claims for personal and property damage are excluded if they are due to one or more of the following causes:

- Improper use of the device.
- Improper installation, operation, use, and maintenance of the pressure equipment.
- Ignoring instructions in the manual with respect to transport, storage, mounting, installation, operation, maintenance, and upgrading of the pressure apparatus.
- Unauthorized alterations to the pressure apparatus.
- Inadequate monitoring of equipment which are subject to wear.
- Improper repairs.
- Exceeding or falling below the temperature range specified in the data sheet during operation or during storage.
- Disaster caused by foreign objects and forces of nature.

4 Safety instructions



The ALSI EX must not be used in explosion hazard zones.



The voltage value printed on the type plate must be respected.



Open the device only when no power is supplied to it.



Electrical installations must be carried out by professionals in accordance with the Installation Order DS/EN 60364.



Check the electrical equipment for the equipment regularly. Exchange loose connections and damaged cables immediately.



If work on parts supplied with power is necessary, a second person must be present to turn off the central power switch if necessary.



Only operate the ALSI EX if the housing including all connections are undamaged. Turn off power to a damaged instrument immediately.



Lay out cable that it does not present a trip hazard.



Clean using a slightly damp cloth with soap solution.

4.1 User responsibilities

The user agrees to only allow people to work at the pressure device, who

- have read and understood the safety chapter and the warnings in this manual. These employees are trained and instructed to work at the gas manifolds or panels.
- The responsibilities of personnel for mounting, installation, and operation must be clearly defined.
- Trainees must work at the pressure device only under the supervision of an experienced person.
- All safety instructions and warnings must be kept in legible condition.

4.2 Personnel duties

All persons who are authorized to work at the pressure device must observe the basic regulations on workplace safety and accident prevention, and familiarize them-selves with the safety data for the type of gas used before starting work.

5 Identification

5.1 Name plate

On the right side of the ALSI EX, you can find a type plate with information about:

Manufacturer, type, serial number, power supply, temperature range, IP protection, CE marking, and Ex marking (if the device has the appropriate equipment).

Type ALSI 4k-EX - 4 channel monitoring	
Supply	230VAC 15W
Input	U/I
P. no	2612
Made in Denmark	
Comadan A/S Messingvej 60	
DK - 8940 Randers	
Phone: 8644 7877	
www.comadan.com	

6 Use

6.1 Function

The ALSI EX is a permanent, continuously operating control unit for transmitter to monitor the contents of pressurized containers. In conjunction with the pressure transmitters mounted at the manifolds or cylinder scales with a signal output of 4 - 20 mA, up to 4 channels can be displayed. Further more passive current sensor signals (i.e. Contact Manometers) can be processed aswell.

The top and bottom level for each channel, and the alarm level for each channel can be configured independently.

There are 2 alarm outputs that work as a common alarm, i.e. an alarm that activates if the alarm level is exceeded on any of the 4 channels.

Alarm 1: Is a continuous alarm, which can be used for a flashing light alarm, for example.

A continuous alarm means that the alarm is active as long as the alarm limits are being exceeded.

Alarm 2: Is an alarm that can deactivated via the touch button on the front of the box. It is typically used for an external acoustic alarm.

Both alarm outputs contain:

- Single pole changeover relay 230 VAC – max 6 amps. -
Output: 24 VDC – max 100 mA.

6.2 Use in hazardous areas



The ALSI 4K EX model may only be connected to the pressure sensors of the companies BD Sensors and Siemens (others on request). The ALSI 4k EX version must not be installed in EX-zone either, only receiving signals from EX-zones.



These notes indicate hazards which cause with high probability injuries or even death if they are not avoided..



The ALSI EX monitoring system may only be installed in non EX zone.

7 Installation

7.1 General

Check equipment immediately after unpacking for any visible damage. If damage is evident, please contact the distributor.

Delivery includes:

- ALSI EX monitoring system
- 4 x wall mount
- Instructions

When mounting the device, locations with the following negative conditions should be avoided:

- Heat (heater or direct sunlight)

7.2 Wall mounting (without bracket)

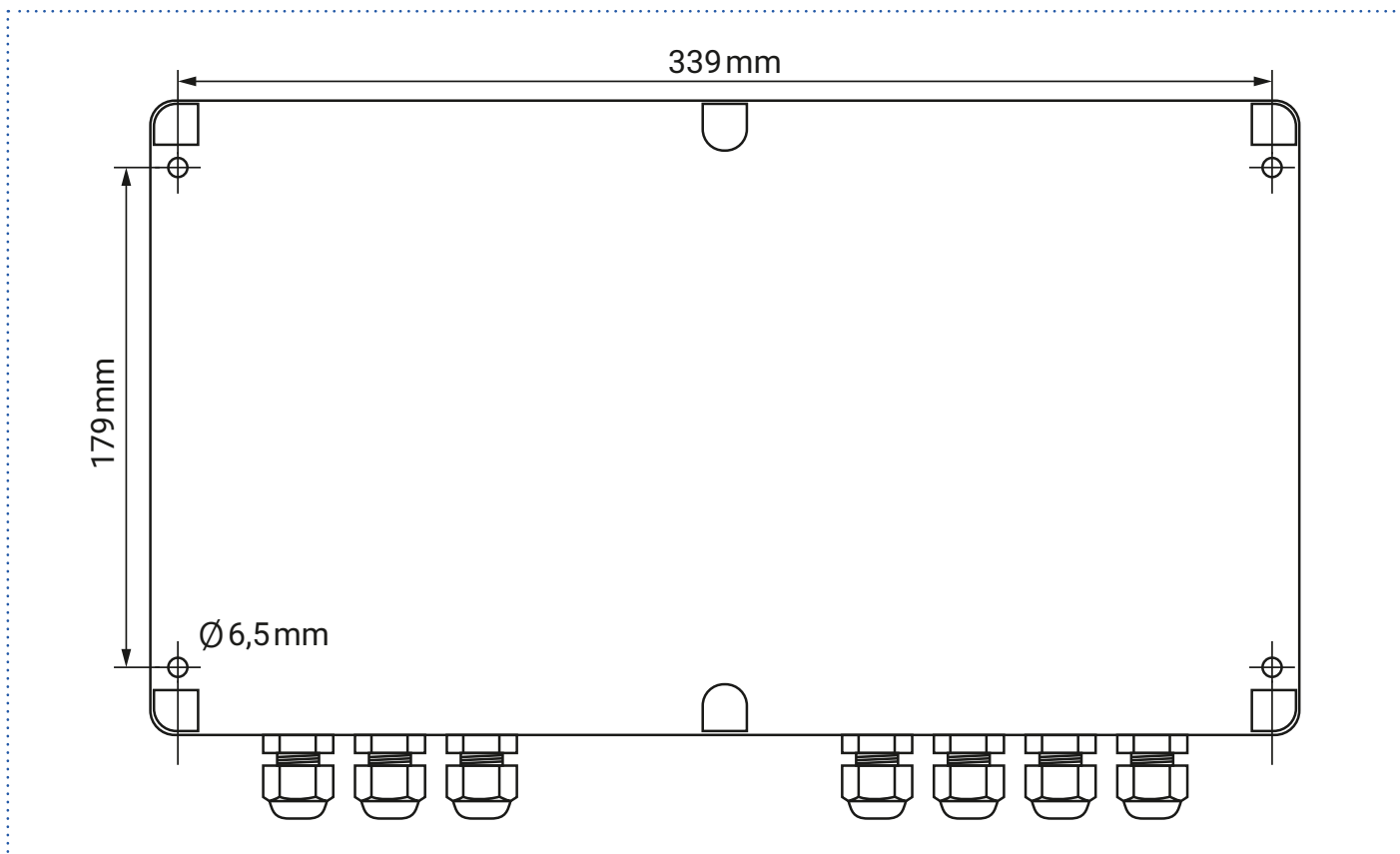

7.3 Create mains connection

The main connection is established via the Schuko connection.

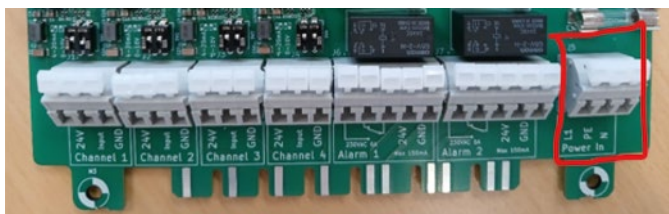

A wire with Type F (Schuko) connection is already mounted in the scope of delivery to the ALSI EX and can be directly plugged in a 230 V (+/-10 %) / 50 Hz circuit.

The ALSI EX however can also be directly connected to the power supply via cables using via 3 connections for the supply of the PCB. L for phase, N for neutral and PE for ground.



WARNING

The printed voltage rating (see type label) must match with the local voltage.



NOTICE

The mains connection may only be conducted by qualified personnel with the appropriate specialist knowledge.



CAUTION

The protective conductor must never be interrupted. It is important to ensure that only standard cable can be used with the protective conductor.

7.4 Sensor connections for Ex models

Connection of the pressure transmitter, weight or contact manometer wires takes place to the input terminals on the built-in EX barriers. The connected devices must fulfill the requirement to operate in an Ex-environment and must be connected by a blue cable to indicate that.



When connecting, switch off (disconnect power supply).

Connecting sensor with "Blue cable"

Sensors are connected by „Blue cable“ from the sensors to the input terminals on the built-in EX barriers.

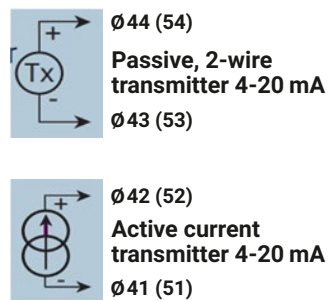
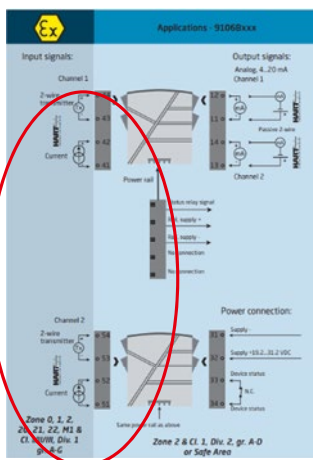

Alarms:

There are 5 connections per alarm: 3 for a changeover relay and 2 for a 24 V output which is turned on when the alarm is activated. The 24V is not galvanically isolated from the alarm.

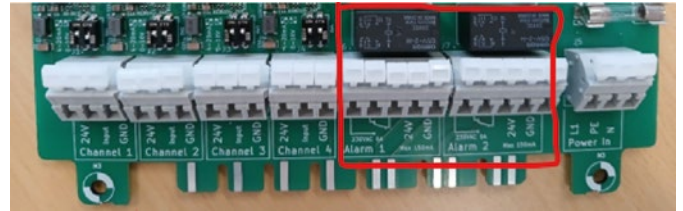

Lamp on alarm:

If desired, a lamp can be switched on by the relay outputs as follows:

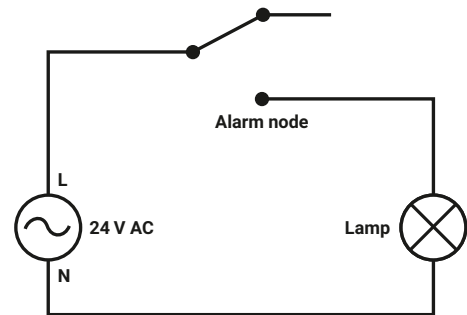

Supply:

There are 3 connections for the supply of the PCB. L for phase, N for neutral, and PE for ground.



The pressure transmitter may only be connected by qualified personnel appropriate specialist knowledge. Installation instructions for the pressure transmitter must be adhered to.

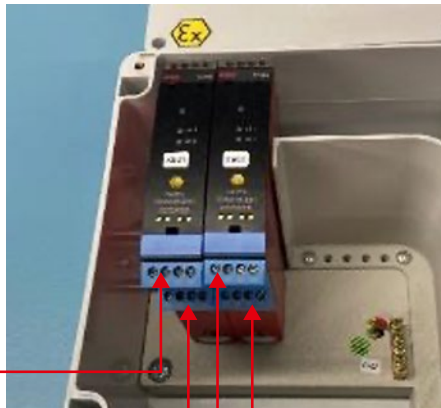

- XB01 chanal 1 = Chanal 1 on Bar-graph
- XB01 chanal 2 = Chanal 2 on Bar-graph
- XB02 chanal 1 = Chanal 3 on Bar-graph
- XB02 chanal 2 = Chanal 4 on Bar-graph

8 Starting Operation

8.1 Overview

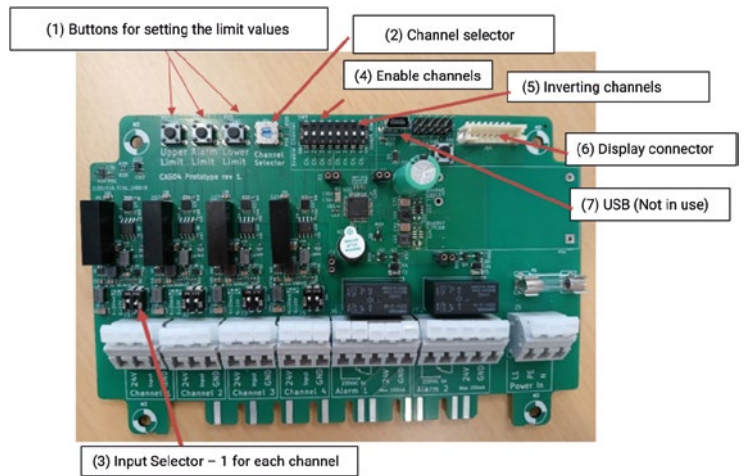
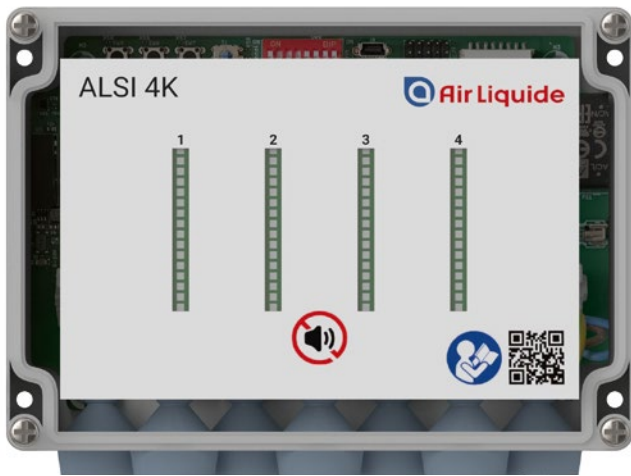

Explanation:

- (1) Buttons for setting the limit value for the selected channel (2):
Upper limit: Sets the upper limit (i.e. the value that corresponds to full scale on the display).
Lower limit: Sets the lower limit (i.e. the value that corresponds to zero on the display).
Alarm limit: Sets the alarm level (where the alarm activates and the bar changes to red).
- (2) Channel selector: You turn the switch until it is on the channel you want to set.
- (3) Input selector: Here you switch between 0–10 V and 4–20 mA signal. (see Fig 1)

- (4) Activation channel: Here you can turn the individual channels on and off. (a channel off shows nothing in the display).
- (5) Inversion of the channel: Here you switch between whether the alarm pulls when the alarm limit is above or below the measured value. At ON, the alarm threshold is at the bottom of the scale, which indicates alarm when pressure decreases.
- (6) Display connector: Here connects the cable for the display.
- (7) USB. Not in use. For internal testing and quality control.

8.2 Configuring the channel

8.2.1 Lid is unscrewed from the box.

To do so, unscrew the four screws on top of the lid and take the lid away. You should now see the board.

8.2.2 Select whether the channel should be enabled on "Enable channels"

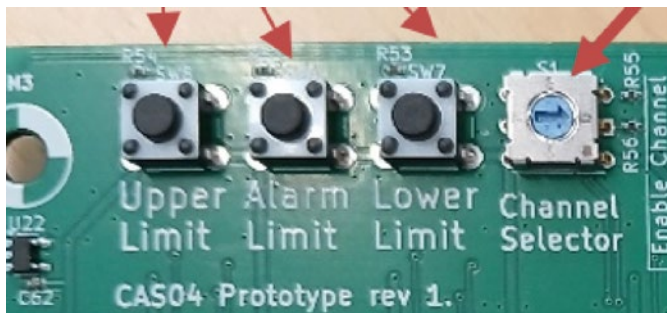

- Arrow at 3 o'clock position means that channel 1 is activated
- Arrow at 6 o'clock position means that channel 2 is activated
- Arrow at 9 o'clock position means that channel 3 is activated
- Arrow at 12 o'clock position means that channel 4 is activated

8.2.3 Select whether the channel is inverted or not (5).

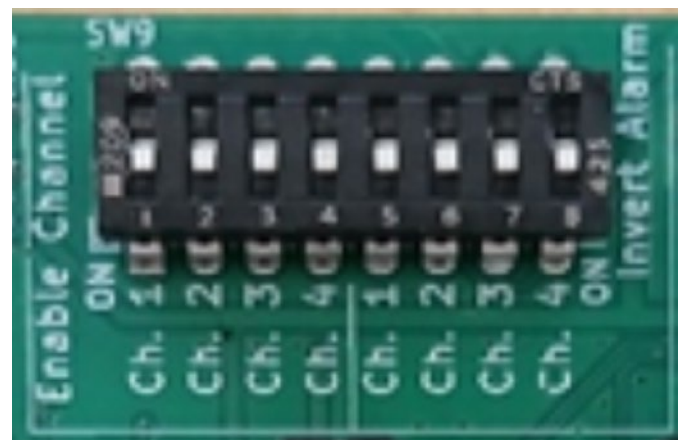

8.2.4 Select if the chosen channel should be

- nominally opened (switch is on the upper side)
- nominally closed (switch is down, as seen)

8.2.5 On the input selector (3), select 0-10V / 4-20mA.

Whether a pressure transmitter, weight or contact manometer is connected to the channel the unit of the signal might be different. Please choose the correlating signal for the relevant channel.



The setting, how the adjust the switches to the desired result can be seen in figure 1

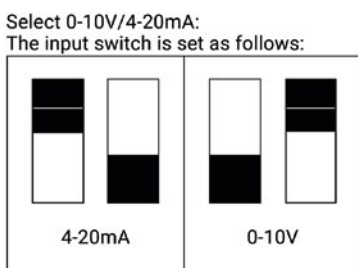

Figure 1

8.2.6 Top, bottom and alarm levels are set as follows:

This step can only be performed when all pressure related components are mounted to Cylinder/Bundle.

8.2.6.1 Set upper limit for Pressure Transmitter and Contact Manometer

8.2.6.1.1 Induce the desired signal level for the upper limit:

- Open the Cylinder valve of an full Bundle or Cylinder and shut down valve of the manifold slowly.
- Depending of the filling pressure of the bundle, which is stated on the name plate (i.e. 25/200/300 bar), the actual filling pressure is shown at the manometer (see green arrow in the Picture).
- Close the Cylinder valve and shut down valve of the manifold.



8.2.6.2 Set Alarm level for Pressure Transmitter and Contact Manometer

8.2.6.2.1 Induce the desired signal level for the Alarm limit:

- Open purging valve slowly so that the pressure in the valve block of the manifold is dropping, this can be seen on the pressure manometer.
- Close the purging valve at the desired alarm pressure level (i.e. see red arrow in the Picture).

8.2.6.2.2 Set Alarm Limit Level

- Press the appropriate alarm limit button.
- The display segments for the channel flashes once.
- The configuration is now saved.

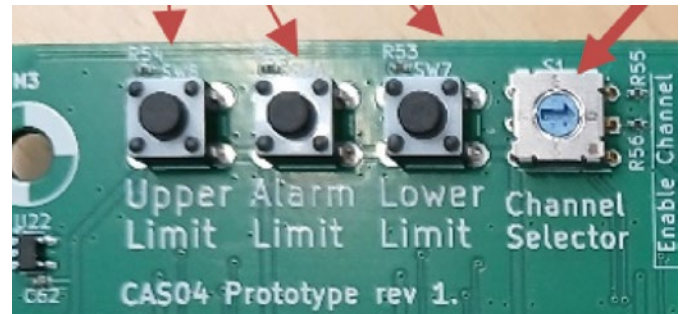

8.2.6.2.3 Set Alarm level for Contact Manometer

Adjust the red mark on the manometer according to the desired alarm level.

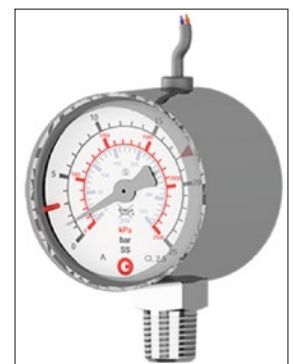

8.2.6.3 Set lower limit for Pressure Transmitter and Contact Manometer

8.2.6.3.1 Induce the desired signal level for the lower limit:

- Open purging valve slowly so that the pressure in the valve block of the manifold is dropping, this can be seen on the pressure manometer. For the lower limit the Manometer should show 0 bar.
- Close the purging valve at the desired alarm pressure level. (i.e. see black arrow in the Picture).



8.2.6.3.2 Set Lower Limit Level

- Press the appropriate lower button.
- The display segments for the channel flashes once.
- The configuration is now saved.

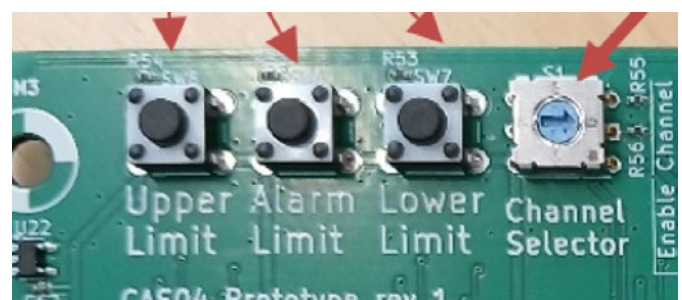

8.2.6.4 Set upper limit for weight

8.2.6.4.1 Induce the desired signal level for the upper limit:

- Put a full cylinder on the weight.
- Open the Cylinder valve and shut down valve of the manifold slowly.
- Depending of the filling pressure of the bundle, which is stated on the name plate (i.e. 25/200 bar), the actual filling pressure is shown at the manometer. (see green arrow in the Picture)
- Close the Cylinder valve and shut down valve of the manifold.

8.2.6.4.2 Set top Limit Level

- Press the appropriate upper limit button.
- The display segments for the channel flashes once.
- The configuration is now saved.

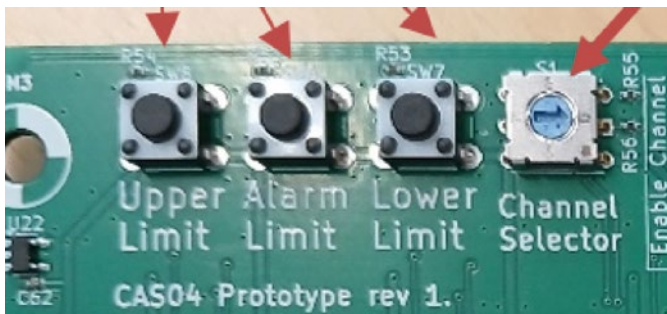

8.2.6.5 Set Alarm level for Weight

8.2.6.5.1 Induce the desired signal level for the lower limit:

The setting of the alarm for a weight can only be performed during operation of the manifold. Which means that the content of the Cylinder has used to a certain level, which is shown at the Manometer of the manifold. When setting the Alarm Level at ALSI EX the operation of the manifold must be stopped. The Cylinder and shut down valve of the manifold must be closed.

8.2.6.5.2 Set Alarm Limit Level

- Press the appropriate alarm limit button.
- The display segments for the channel flashes once.
- The configuration is now saved.

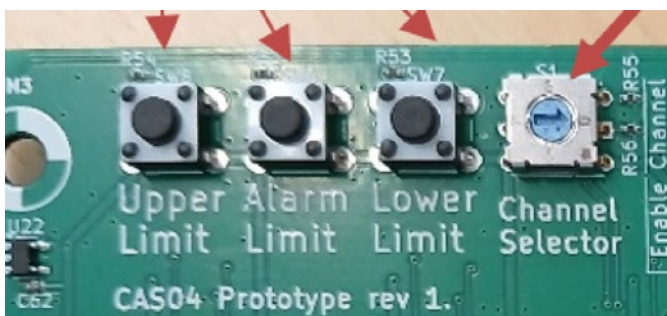

8.2.6.6 Set Alarm level for Weight

8.2.6.6.1 The setting of lower limit for a weight can only be performed with an empty cylinder or after operation of the manifold when the cylinder shows a level at the manometer, where the process can not be held upright.

8.2.6.6.2 Set Alarm Limit Level

- Press the appropriate alarm limit button.
- The display segments for the channel flashes once.
- The configuration is now saved.

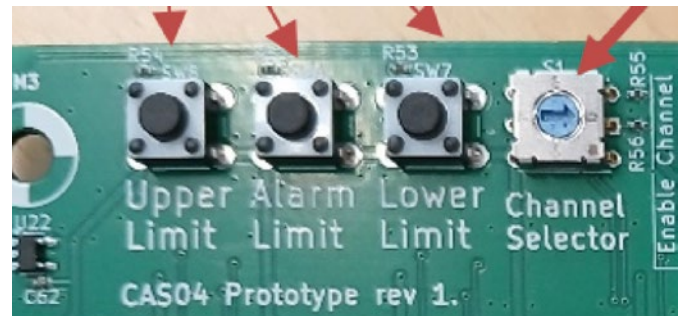

8.2.6.7 Repeat for the other channels from step 2.

8.2.6.8 Put the lid back on the box again.

8.3 Alarm 2 – Deactivation

Disable it by pressing the button on the front.

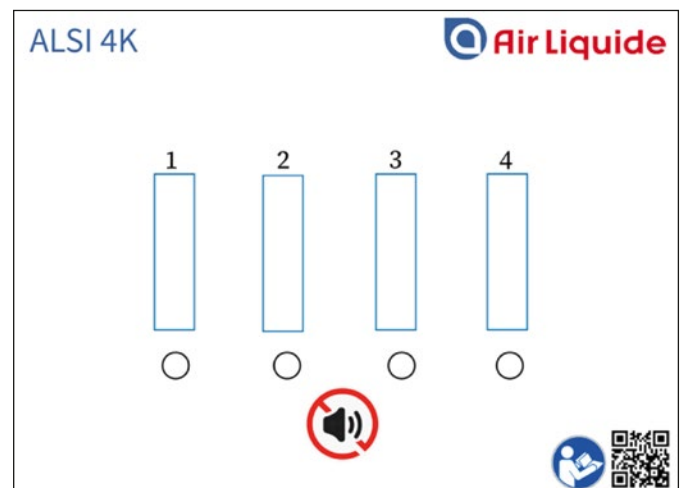

Both alarm outputs contain:

- Single pole changeover relay 230 V_{AC} – max 6 amps. – Output: 24 V_{DC} – max 100 mA.

Declaration of conformity

Issued May 2025

We hereby declare that the monitoring unit with bar-graph display and alarm

Type: ALSI 4K is a 4-channel monitoring unit with level display and adjustable alarm limit.

Category: Bar-graph display
Producer: Comadan A/S
Messingvej 60
DK- 8940 Randers SV

Country of origin: Denmark

Are in conformity with the provisions of
Emmision: EN 50 081 - 1
Immunitet: EN 50 082 - 2
Sikkerhed: EN 60 730

And have been manufactured according to the following harmonized standards:
EN 61000-6-1
EN 61000-6-3

RoHS II and REACH:

We are committed to manage the use of chemical substances in accordance with governmental regulations, industry standards, and customer-specific requirements in order to protect the environment.

2011/65/EU (RoHS II)

We hereby certify that all of our products fully comply with The European RoHS Directive

2002/95/EC (RoHS I) and its subsequent amendments 2011/65/EU (RoHS II). Homogeneous materials of parts that are compliant to this legislation have less than 0.1 % by weight each of lead, mercury, hexavalent chromium, PBB, and PBDE, and 0.01 % by weight of cadmium. In situations where an exemption applies, the preceding limits, corresponding to the exempted substance(s), may be higher.

(EC) NO 1907/2006 (REACH)

We hereby also certify that none of our products contain Substances of Very High Concern (SVHC) as listed by the European Chemicals Agency (ECHA) under the provisions of Regulation (EC) No. 1907/2006 of the European Parliament and of the council concerning the Registration, Evaluation, Authorization, and Restriction of Chemicals (REACH) per the ECHA 20/12/2010 and previous updates and included the Regulation (EU) No 2015/830 from 25 May 2015 amending Annex II and III.

The status of the candidate list (SVHC) will continue to be monitored, as established under Article 33 of REACH to inform product recipients and consumers if any substance or preparations of an article contains more than 0.1 % by weight per article of any substance that is added to the SVHC candidate list in the future.

WE FIRE IN CONTROL
Messingvej 60 • DK8940 Randers SV
+45 86 44 73 77 • Email: Sales@comadan.com
VAT: DK6532955



Best regards
Jens Nygaard Jensen
Comadan A/S
Messingvej 60
8940 Randers SV

10 Wiring diagram

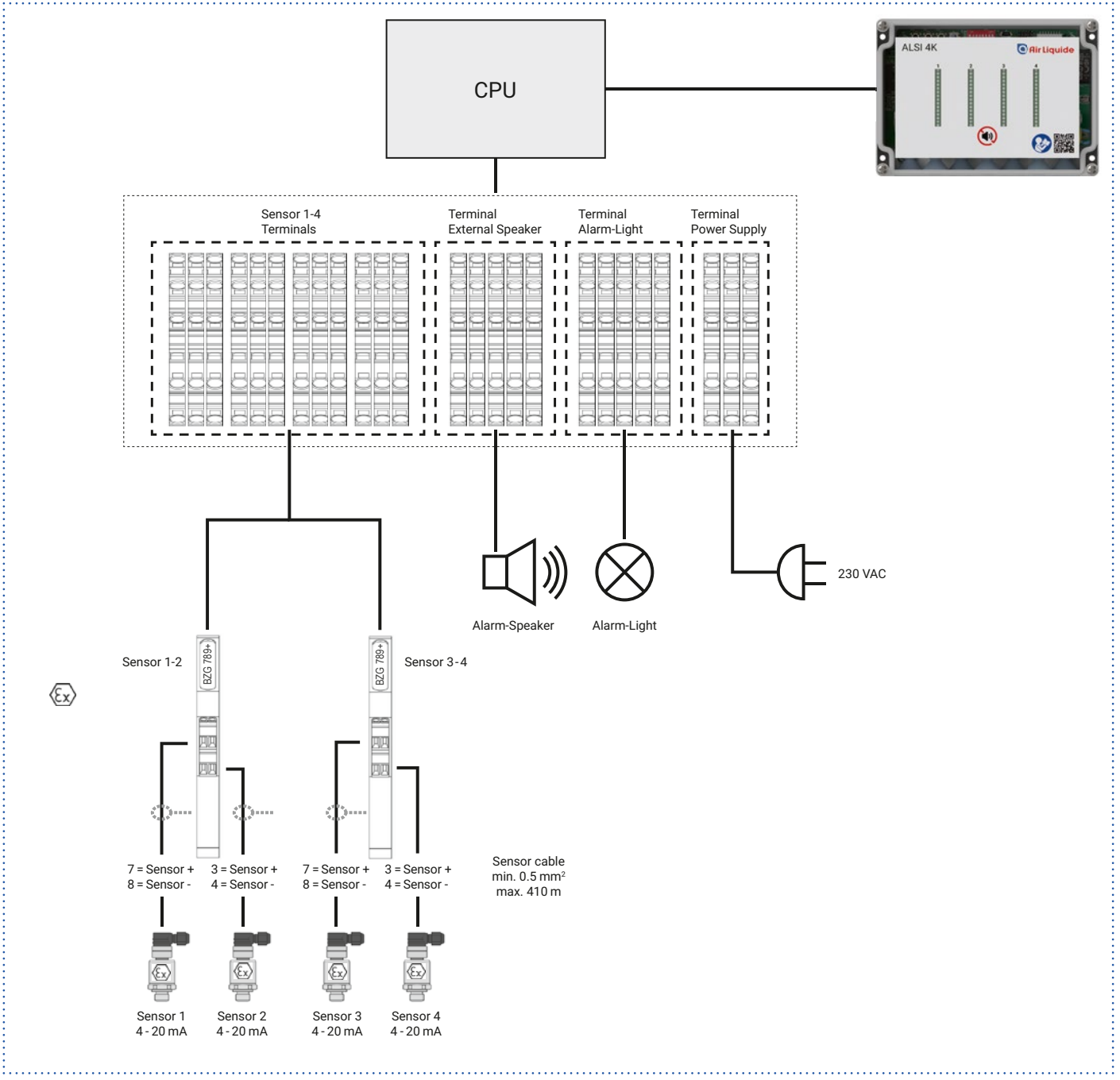



www.airliquide.com



Gebrauchsanleitung / Operating Instructions / Manuel d'utilisation / Istruzioni per l'uso

Contact

Air Liquide Austria GmbH
Sendnergasse 30
2320 Schwechat
Tel: +43 810 242427
technik.at@airliquide.com
www.airliquide.at

Air Liquide Belgium
Tel: +32 2793 3841
contact.be@airliquide.com

Air Liquide Denmark
Tel: 76 25 25 95
kundeservice.denmark@airliquide.com
dk.airliquide.com

Air Liquide Deutschland GmbH
Fütingsweg 34
47805 Krefeld
Tel: +49 (0) 2151 379 - 9444
equipment@airliquide.com
www.airliquide.de

Air Liquide Finland
Tel: 020 779 0586
laskutus.finland@airliquide.com
fi.airliquide.com

Air Liquide Luxembourg
Tel: 20881137
contact.lu@airliquide.com

Air Liquide Netherlands
Achtseweg Zuid 151F
5651 GW Eindhoven
Tel: 20 795 6621
contact.nl@airliquide.com

Air Liquide Norway
Tel: 32 27 41 40
kundeservice.norway@airliquide.com
no.airliquide.com

Air Liquide Sweden
Tel: 020 440144
kundservice.sweden@airliquide.com
<https://se.airliquide.com>

Air Liquide United Kingdom
Air Liquide UK Limited
Station Road
Coleshill - Birmingham B46 1JY.
Tel: +44 (0) 1782 822061
Fax: +44 (0) 1782 826850
specgas.aluk@airliquide.com

Carbagas AG
Hofgut
3073 Gümligen
Tel: +41 31 95 05050
info@carbagas.ch
www.carbagas.ch

www.airliquide.de



A world leader in gases, technologies and services for Industry and Health, Air Liquide is present in 60 countries with approximately 66 500 employees and serves more than 4 million customers and patients.